

**Triple Constellations GNSS Mouse for
GPS/GLONASS/Galileo satellites
PGM-3535 Specification**

Version 1.0
2022/09/20

This document contains information highly confidential to KNCTEK Company LTD (KNCTEK). It is provided for the sole purpose of the business discussion between specific Users and KNCTEK and is covered under the terms of the applicable Non-Disclosure Agreements. Disclosure of this information to other parties is prohibited without the written consent of KNCTEK.

KNCTEK Company LTD.

6F03, Ace High-End Tower 6th, 60-25,

Gasam-dong, Geumcheon-gu

SEOUL, KOREA

TEL: 82-2-839-5701

FAX: 82-2-830-5703

E-Mail: knc3@knctek.co.kr

<http://www.knctek.co.kr>

PGM-3535 Specification

REVISION HISTORY	3
INTRODUCTION	4
PRODUCT FEATURES	4
PRODUCT APPLICATIONS	4
PRODUCT PICTURE & DIMENSION PRODUCT PICTURE	5
PGM-3535 SYSTEM BLOCK DIAGRAM	5
TECHNICAL SPECIFICATION	6
ORDERING INFORMATION.....	9
HARDWARE INTERFACE	10
I/O INTERFACE.....	12
PACKING SPECIFICATION	13
GPS/GLONASS/Galileo RECEIVER USER'S TIP	14
NMEA PROTOCOL	15
CONTACT INFORMATION SECTION	24

Revision History

1. 2022-09-20 : Initiated Version 1.0

PGM-3535 Operational Manual

INTRODUCTION

The **PGM-3535** is the newest generation of KNCTEK GPS/GLONASS/Galileo GNSS Mouse. The GPS/GLONASS/Galileo GNSS Mouse is powered by SkyTraq technology and KNCTEK's proprietary navigation algorithm that provide you more stable navigation data. The miniature design is the best choice to be embedded in the portable devices, various Trackers, Vehicle & Personal Locaters and etc. The excellent sensitivity of **PGM-3535** gets the great performance when going through the urban canyon and foliage environmental condition.

PRODUCT FEATURES

- ✧ GPS, GLONASS, Galileo, QZSS, SBAS(WAAS, MSAS, EGNOS, GAGAN) supported
- ✧ 230 Acquisition & Tracking Channels
- ✧ Operable from 3.3V to 5.5V / 62mA for Acquisition and 48mA for Tracking Mode
- ✧ Signal Detection better than -165dBm in Ultra High Tracking Sensitivity
- ✧ Enhanced Cold Acquisition Sensitivity at -148dBm and Reacquisition at -160dBm
- ✧ 28 seconds in Warm start and 29 seconds for Cold start under open sky average
- ✧ Advanced Multipath detection and suppression
- ✧ Jamming detection and mitigation
- ✧ SAEE(Self-aided ephemeris estimation) Supported
- ✧ Excellent Sensitive for Urban Canyon and Foliage Environmental condition
- ✧ NMEA-0183 compliant protocol
- ✧ Automotive-grade Quality GPS/GLONASS/Galileo solution
- ✧ Small form factor(50 x 60 x 16mm)
- ✧ ODM/OEM development is fully supported Application Engineering
- ✧ RoHS compliant

PRODUCT APPLICATION

- ✧ Automotive applications
- ✧ Speed camera detector
- ✧ Personal and Car navigation
- ✧ Marine navigation
- ✧ Timing application and the others

PRODUCT PICTURE

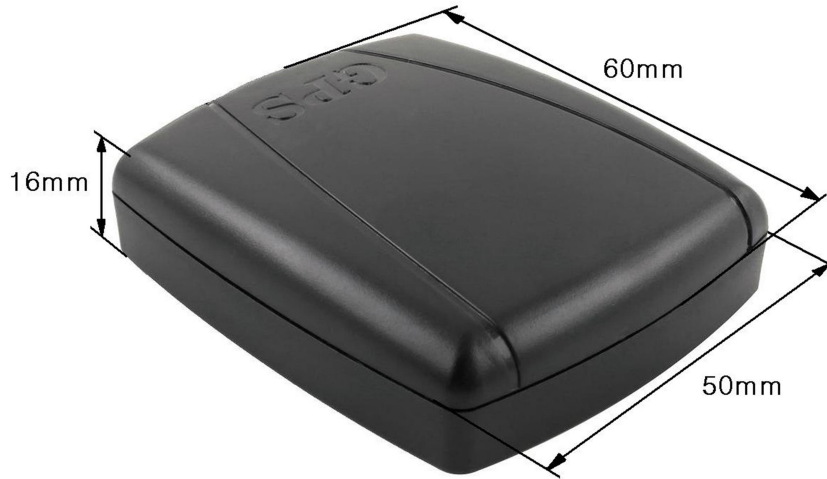

PGM-3535 SYSTEM BLOCK DIAGRAM

The PGM-3535 consists of SkyTraq chipsets Technology, KNCTEK LNA and proprietary software. The system is described as follows.

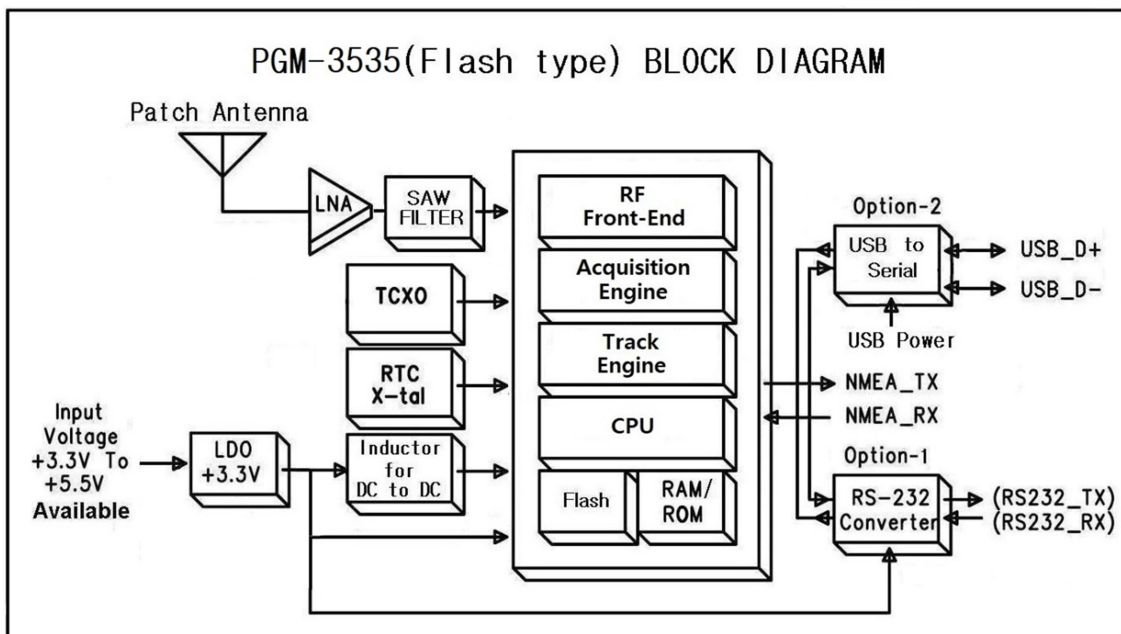

TECHNICAL SPECIFICATION
1. Electrical Characteristics
1.1 Absolute Maximum Rating

Parameter	Symbol	Min	Max	Units
Power Supply				
Power Supply Voltage for TTL & RS232	VCC	-0.3	6	V
Power Supply Voltage for USB	VCC_USB	-0.3	5.8	V
Input Pins				
Input Pin Voltage I/O	RX	-0.3	3.6	V
Backup Battery	Vbat	1.8	3.6	V
Environment				
Operating Temperature	Topr	-30	85	°C
Storage Temperature	Tstg	-40	85	°C
Backup Battery operating temperature ¹	Tbat	-20	60	°C

** ¹ Backup Battery operating temperature depends on Battery characteristics

Note : Absolute maximum ratings are stress ratings only, and functional operation at the maximums is not guaranteed. Stress beyond the limits specified in this table may affect device reliability or cause permanent damage to the device.

For functional operating conditions, please refer to the operating conditions tables as follow.

1.2 Operating Condition

Parameter	Symbol	Condition	Min	Typ	Max	Units
Power supply voltage						
for TTL & RS232	Vcc		3.3	5.0	5.5	V
for USB	Vcc		4.0	5.0	5.25	V
Power Supply voltage ripple	Vcc_PP	Vcc = 3.3 ~ 5.5V			50	mV
Acquisition current	IccA	Vcc = 3.3 ~ 5.5V		62		mA
Tracking current	IccT	Vcc = 3.3 ~ 5.5V		48		mA
Input Voltage						
Input high voltage for TTL	V _{IH}		2.0			V
Input low voltage for TTL	V _{IL}				0.8	V
Input range for RS232	V _{IR}		-15		+15	V

Differential Input Sensitivity for USB	V _{DI}		0.2			V
Differential Input Common Mode Range for USB	V _{CM}		0.8		2.5	V
Output Voltage						
Output high voltage for TTL	V _{OH}		2.4			V
Output high voltage for USB	V _{OH}		2.8			V
Output low voltage for TTL	V _{OL}				0.4	V
Output low voltage for USB	V _{OL}				0.8	V
Output Voltage swing for RS232	V _{OS}		±5.0	±5.4		V

※ **Caution : In USB type, the cable length between Mouse and USB connector should be within 1M or less than Maximum 1.5M for stable operation of USB(to Serial) Communication.**

2. General & Performance Specification

Parameter	Specification	
Receiver Type	GPS/GLONASS/Galileo, 230 Acquisition & Tracking Channels	
Sensitivity	Tracking	-165dBm
	Re-acquisition	-160dBm
	Cold Start	-148dBm
Accuracy	Position	2.0m CEP
	Velocity	0.1m/s
	Timing(PPS)	12ns RMS
Acquisition Time	Cold Start	29 sec. typical (Open sky ¹)
	Warm Start	28 sec. typical (Open sky)
	Hot Start	1 sec. typical (Open sky)
	Reacquisition Time	1 sec(Open sky, re-appear after some seconds)
Power Consumption	Tracking	48mA @ 3.3 ~ 5.5V
	Acquisition	62mA @ 3.3 ~ 5.5V
	Back-up	15uA @ 3V
Navigation Data Update Rate	1Hz_Default	In case of using Binary input : Max 25Hz
	** Please refer to the Binary Input Message	

Operational Limits	Velocity	Max 515 m/s		
	Altitude	Max 18,000m		
	Acceleration	Less than 4g(39.2m/sec ²)		
Mechanical data	Dimension	50X60X16mm		
	Weight(with case and cable)	95grams ±5%(3M Cable)		
Protocol	NMEA-0183 V3.01	GNGGA	1Hz	
		GNGLL	1Hz	
		GNGSA	1Hz	
		GPGSV	1/3Hz(one time per 3sec)	
		GLGSV	1/3Hz	
		GAGSV	1/3Hz	
		GNRMC	1Hz	
		GNVTG	1Hz	
		GNZDA	1Hz	

** ¹Open Sky means no obstructions in the sky

ORDERING INFORMATION



Cable for customer request : Refer to page 12 for connector type

- Output Type : TTL output/9,600baud (Default)

If different, please specify your requirement as;

- Option-1
 - Output type : RS-232/9,600baud
 - Connector type : Refer to page 12.
- Option-2
 - Output Type : USB Level/9,600baud
 - Connector type : USB Jack 4Pin
 - Cable Length : 1M

※ **The cable length should be within 1M or less than Maximum 1.5M for stable operation of USB(to Serial) communication.**



HARDWARE INTERFACE

Pin Description

PIN	SIGNAL NAME	I/O	DESCRIPTION	CHARACTER
1	VCC	P	DC Power Supply Voltage input	DC 3.3V to 5.5V Acceptable for TTL & RS232/ DC 4.0V to 5.25V for USB
2	TXD	O	UART serial data Output	3.3V LVTTTL or RS232 level
	USB_DP	I/O	I/O Differential USB D+	USB Data+
3	RXD	I	UART serial data Input	3.3V LVTTTL or RS232 level
	USB_DM	I/O	I/O Differential USB D-	USB Data-
4	GND	P	Digital Reference Ground	Digital Reference Ground

VCC DC Power Input

This is the main power supply for the Engine board. The power range is **DC 3.3V to 5.5V Acceptable for TTL & RS232 and DC 4.0V to 5.25V for USB**. Suitable decoupling must be provided by external decoupling circuitry.

GND

GND provides the ground for the Engine board. Connect all grounds.

TXD

NMEA_TX, UART serial data output. This is the main transmit channel and is used to output navigation and measurement data to user written software. The default setup is NMEA Output, 9600bps, 8 data bits, no parity, 1 stop bit. The default sentences are GNGGA, GNGLL, GNGSA, GPGSV, GLGSV, GAGSV, GNRMC, GNVTG, GNZDA.

GNGGA, GNGLL, GNGSA, GNRMC, GNVTG, GNZDA are once per second and GPGSV, GLGSV, GAGSV is once per 3 second.

RXD

NMEA_RX, UART serial data input. This is the main receiving channel and is used to receive software commands to the Engine board from user written software.

USB_DP

Data plus for USB communication.

standard NMEA_0183 sentence or response to input binary command. The default setup is









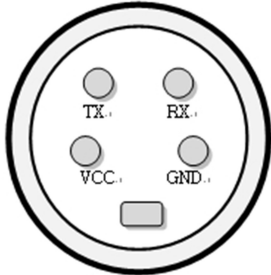

NMEA Output, 9600bps, 8 data bits, no parity, 1 stop bit. The default sentences are GNGGA, GNGLL, GNGSA, GPGSV, GLGSV, GAGSV, GNRMC, GNVTG, GNZDA.

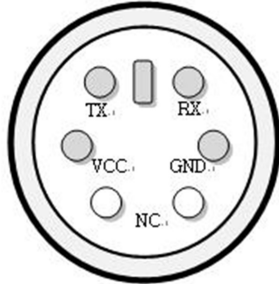
GNGGA, GNGLL, GNGSA, GNRMC, GNVTG, GNZDA are once per second and GPGSV, GLGSV, GAGSV is once per 3 second.

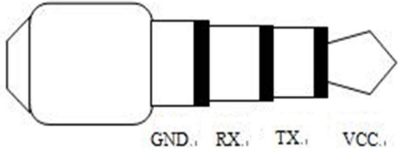
USB_DM

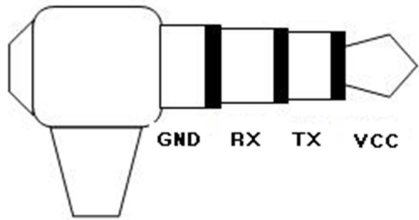
Data minus for USB communication.

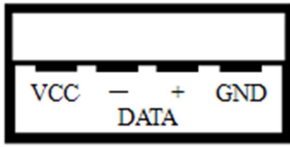
I/O INTERFACE

<p>Mini Din Jack 4pin Φ9.0</p>		
<p>Mini Din Jack 6pin Φ9.0</p>		
<p>Stereo Jack (Straight) Φ2.5 Φ3.5</p>		
<p>Stereo Jack (Angle) Φ2.5 Φ3.5</p>		
<p>USB Jack 4pin</p>		

Packing Information**1. Packing Method**

TBD : To be determined

GPS/GLONASS/Galileo Receiver User's Tip

1. GPS/GLONASS/Galileo signal will be affected by weather and environment conditions, thus suggest to use the GPS/GLONASS/Galileo receiver under less shielding environments to ensure GPS/GLONASS/Galileo receiver has better receiving performance.
2. When GPS/GLONASS/Galileo receiver is moving, it will prolong the time to fix the position, so suggest to wait for the satellite signals to be locked at a fixed point when first power-on the GPS/GLONASS/Galileo receiver to ensure to lock the GPS/GLONASS/Galileo signal at the shortest time.
3. The following situation will affect the GPS/GLONASS/Galileo receiving performance:
 - a. Solar control filmed windows.
 - b. Metal shielded, such as umbrella, or in vehicle.
 - c. Among high buildings.
 - d. Under bridges or tunnels.
 - e. Under high voltage cables or nearby radio wave sources, such as mobile phone base stations.
 - f. Bad or heavy cloudy weather.
4. If the satellite signals cannot be locked or encounter receiving problem (while in the urban area), the following steps are suggested:
 - a. Move to another open space or reposition GPS/GLONASS/Galileo receiver toward the direction with fewer blockages.
 - b. Move the GPS/GLONASS/Galileo receiver away from the interference resources.
 - c. Wait until the weather condition is improved.

While a GPS/GLONASS/Galileo with a backup battery, the GPS/GLONASS/Galileo receiver can fix a position immediately at next power-on if the build-in backup battery is full-recharged.

NMEA Protocol Overview

The output protocol supports NMEA-0183 standard. The implemented message include GGA, GLL, GSA, GSV, VTG, RMC and ZDA messages. The NMEA message output has the following sentence structure:

`$aacc,c-c*hh<CR><LF>`

The detail of the sentence structure is explained in Table 1.

Table 1 : The NMEA sentence structure

character	HEX	Description
"\$"	24	Start of sentence
Aaacc		Address field. "aa" is the talked identifier. "ccc" identifies the sentence type
","	2C	Field delimiter
C-c		Data sentence block
"*"	2A	Checksum delimiter
Hh		Checksum field.
<CR><LF>	0D0A	Ending of sentence. (carriage return, line feed)

Table 2 : Overview of NMEA messages

\$GNGGA	Time, position, and fix related data of the receiver.
\$GNGLL	Position, time and fix statue.
\$GNGSA	Used to represent the ID's of satellites which are used for position fix. When GPS satellites are used for position fix, \$GNGSA sentence is output with system ID 1. When GLONASS satellites are used for position fix, \$GNGSA sentence is output with system ID 2. When Galileo satellites are used for position fix, \$GNGSA sentence is output with system ID 3.
\$GPGSV \$GLGSV \$GAGSV	Satellite information about elevation, azimuth and CNR, \$GPGSV is used for GPS satellites, while \$GLGSV is used of GLONASS satellites, while \$GAGSV is used of Galileo satellites
\$GNRMC	Time, date, position, course and speed data.
\$GNVTG	Course and speed relative to the ground
\$GNZDA	UTC, day, month and year and time zone.

GGA - Global Positioning System Fix Data

Time, position and fix related data for a GPS receiver.

Structure:

```
$--GGA,hhmmss.sss,ddmm.mmmmm,a,dddmm.mmmmm,a,x,xx,x.x,x.x,M,x.x,M,x.x,xxxx*hh<CR><LF>
```

1 2 3 4 5 6 7 8 9 10 11 12 13

Example:

```
$GNGGA,111636.932,2447.09495,N,12100.52235,E,1,11,0.8,118.2,M,21.3,M,,0000*02<CR><LF>
```

Field	Name	Example	Description
1	UTC Time	111636.932	UTC of position in hhmmss.sss format, (000000.000 ~ 235959.999)
2	Latitude	2447.09495	Latitude in ddmm.mmmmm format Leading zeros transmitted
3	N/S Indicator	N	Latitude hemisphere indicator, 'N' = North, 'S' = South
4	Longitude	12100.52235	Longitude in dddmm.mmmmm format Leading zeros transmitted
5	E/W Indicator	E	Longitude hemisphere indicator, 'E' = East, 'W' = West
6	GPS quality indicator	1	GPS quality indicator 0: position fix unavailable 1: valid position fix, SPS mode 2: valid position fix, differential GPS mode 3: GPS PPS Mode, fix valid 4: Real Time Kinematic. System used in RTK mode with fixed integers 5: Float RTK. Satellite system used in RTK mode. Floating integers 6: Estimated (dead reckoning) Mode
7	Satellites Used	11	Number of satellites in use, (00 ~ 24)
8	HDOP	0.8	Horizontal dilution of precision, (00.0 ~ 99.9)
9	Altitude	108.2	mean sea level (geoid), (-9999.9 ~ 17999.9)
10	Geoidal Separation	21.3	Geoidal Separation in meters
11	Age of Differential	0000	Age of Differential GPS data

	GPS data		NULL when DGPS not used
12	DGPS Station ID	0000	Differential reference station ID, 0000 ~ 1023
13	Checksum	02	

GLL – Latitude/Longitude

Latitude and longitude of vessel position, time of position fix and status.

Structure:

\$--GLL,ddmm.mmmmm,a,dddmm.mmmmm,a,hhmmss.sss,A,a*hh<CR><LF>
 1 2 3 4 5 6 7 8

Example:

\$GNGLL,2447.09495,N,12100.52235,E,112609.932,A,A*57<CR><LF>

Field	Name	Example	Description
1	Latitude	2447.09495	Latitude in ddmm.mmmmm format Leading zeros transmitted
2	N/S Indicator	N	Latitude hemisphere indicator 'N' = North 'S' = South
3	Longitude	12100.52235	Longitude in dddmm.mmmmm format Leading zeros transmitted
4	E/W Indicator	E	Longitude hemisphere indicator 'E' = East 'W' = West
5	UTC Time	112609.932	UTC time in hhmmss.sss format (000000.000 ~ 235959.999)
6	Status	A	Status, 'A' = Data valid, 'V' = Data not valid
7	Mode Indicator	A	Mode indicator 'N' = Data not valid 'A' = Autonomous mode 'D' = Differential mode 'E' = Estimated (dead reckoning) mode
8	Checksum	57	

GSA – GNSS DOP and Active Satellites

GNSS receiver operating mode, satellites used in the navigation solution reported by the GGA or GNS sentence and DOP values.

Structure:

```
$--GSA,A,x,xx,xx,xx,xx,xx,xx,xx,xx,xx,xx,xx,xx,x,x,x,x,x*hh<CR><LF>
    1 2 3 3 3 3 3 3 3 3 3 3 3 3 4 5 6 7
```

Example:

```
$GNGSA,A,3,05,12,21,22,30,09,18,06,14,01,31,,1.2,0.8,0.9*36<CR><LF>
$GNGSA,A,3,69,70,73,79,80,,,,,,,,,1.2,0.8,0.9*3C<CR><LF>
```

Field	Name	Example	Description
1	Mode	A	Mode 'M' = Manual, forced to operate in 2D or 3D mode 'A' = Automatic, allowed to automatically switch 2D/3D
2	Mode	3	Fix type 1 = Fix not available 2 = 2D 3 = 3D
3	Satellite used 1~16	05,12,21,22,30,09,18,06,14,01,31,,	Satellite ID number, 01 ~ 32 are for GPS; 33 ~ 64 are for WASS(PRN minus 87); 193 ~ 197 are for QZSS; 65 ~ 96 are for GLONASS(GL PRN); 01 ~ 36 are for Galileo(GA PRN). Maximally 12 satellites are included in each GSA sentence.
4	PDOP	1.2	Position dilution of precision (00.0 to 99.9)
5	HDOP	0.8	Horizontal dilution of precision (00.0 to 99.9)
6	VDOP	0.9	Vertical dilution of precision (00.0 to 99.9)
7	Checksum	36	

GSV – GNSS Satellites in View

Number of satellites (SV) in view, satellite ID numbers, elevation, azimuth, and SNR value. Four satellites maximum per transmission.

Structure:

```
$--GSV,x,x,xx,xx,xx,xxx,xx,...,xx,xx,xxx,xx *hh<CR><LF>
    1 2 3 4 5 6 7 4 5 6 7 8
```

Example:

```
$GPGSV,4,1,16,05,54,069,45,12,44,061,44,21,07,184,46,22,78,289,47*72<CR><LF>
$GPGSV,4,2,16,30,65,118,45,09,12,047,37,18,62,157,47,06,08,144,45*7C<CR><LF>
$GPGSV,4,3,16,14,39,330,42,01,06,299,38,31,30,256,44,32,36,320,47*7B<CR><LF>
$GPGSV,4,4,16,42,64,169,45,50,74,261,44,21,07,184,46,193,68,189,47*72<CR><LF>
```

Field	Name	Example	Description
1	Number of message	4	Total number of GSV messages to be transmitted (1-4)
2	Sequence number	1	Sequence number of current GSV message
3	Satellites in view	16	Total number of satellites in view (00 ~ 16)
4	Satellite ID	05	Satellite ID number, 01 ~ 32 are for GPS; 33 ~ 64 are for WASS(PRN minus 87); 193 ~ 197 are for QZSS; 65 ~ 96 are for GLONASS(GL PRN); 01 ~ 36 are for Galileo(GA PRN). Maximally 4 satellites are included in each GSV sentence.
5	Elevation	54	Satellite elevation in degrees, (00 ~ 90)
6	Azimuth	069	Satellite azimuth angle in degrees, (000 ~ 359)
7	SNR	45	C/No in dB (00 ~ 99) Null when not tracking
8	Checksum	72	

RMC – Recommended Minimum Specific GNSS Data

Time, date, position, course and speed data provided by a GNSS navigation receiver.

Structure:

```
$--RMC,hhmmss.sss,A,dddmm.mmmmm,a,dddmm.mmmmm,a,x.x,x.x,ddmmy,,a*hh<CR><LF>
```

1 2 3 4 5 6 7 8 9 10 11

Example:

```
$GNRMC,111636.932,A,2447.09495,N,12100.52235,E,000.0,000.0,030407,,A*61<CR><LF>
```

Field	Name	Example	Description
1	UTC time	0111636.932	UTC time in hhmmss.sss format (000000.000 ~ 235959.999)
2	Status	A	Status 'V' = Navigation receiver warning 'A' = Data Valid
3	Latitude	2447.09495	Latitude in dddmm.mmmmm format Leading zeros transmitted
4	N/S indicator	N	Latitude hemisphere indicator 'N' = North 'S' = South
5	Longitude	12100.52235	Longitude in dddmm.mmmmm format Leading zeros transmitted
6	E/W Indicator	E	Longitude hemisphere indicator 'E' = East 'W' = West
7	Speed over ground	000.0	Speed over ground in knots (000.0 ~ 999.9)
8	Course over ground	000.0	Course over ground in degrees (000.0 ~ 359.9)
9	UTC Date	030407	UTC date of position fix, ddmmyy format
10	Mode indicator	A	Mode indicator 'N' = Data not valid 'A' = Autonomous mode 'D' = Differential mode 'E' = Estimated (dead reckoning) mode
11	checksum	61	

VTG – Course Over Ground and Ground Speed

The Actual course and speed relative to the ground.

Structure:

\$--VTG,x.x,T,,M,x.x,N,x.x,K,a*hh<CR><LF>
 1 2 3 4 5

Example:

\$GNVTG, 000.0,T,,M,000.0,N,0000.0,K,A*3D<CR><LF>

Field	Name	Example	Description
1	Course	000.0	True course over ground in degrees (000.0 ~ 359.9)
2	Speed	000.0	Speed over ground in knots (000.0 ~ 999.9)
3	Speed	0000.0	Speed over ground in kilometers per hour (0000.0 ~ 1800.0)
4	Mode	A	Mode indicator 'N' = not valid 'A' = Autonomous mode 'D' = Differential mode 'E' = Estimated (dead reckoning) mode
5	Checksum	3D	

ZDA – Time & Date

UTC, day, month, year and local time zone.

Structure:

\$--ZDA,hhmmss.sss,xx,xx,xxxx,xx,xx*hh<CR><LF>

1 2 3 4 5 6 7

Example:

\$GPZDA,052633.376,13,07,2012,00,00*51<CR><LF>

Field	Name	Example	Description
1	UTC time	0111636.932	UTC time in hhmmss.sss format (000000.000 ~ 235959.999)
2	Day	13	Day, 01 to 31
3	Month	07	Month, 01 to 12
4	Year	2012	Year in yyyy format
5	Local zone hours	00	Local zone hours, 00 to +/- 13 hrs
6	Local zone minutes	00	Local zone minutes, 00 to +59
7	checksum	51	

Contact Information Section

Contact : knc3@knctek.co.kr

Web Site: www.knctek.co.kr

Headquarter :

**6F03, Ace High-End Tower 6th, 60-25,
Gasan-dong, Geumcheon-gu
SEOUL, KOREA
TEL: 82-2-839-5701
FAX: 82-2-830-5703**